



®
BUILD A BETTER HOME

DESIGNING ROOFS TO PREVENT MOISTURE INFILTRATION

Today's value-engineered home features the extensive use of engineered wood products in resource-efficient, high-performance building systems for floors, walls, and roofs. Engineered wood products improve on the structural advantages that have made wood such a successful and strong building material for decades. Improper construction, however, can allow moisture to enter the building envelope and lead to problems with mold, mildew, and decay. While outside sources such as rain and melting snow pose the most significant moisture threats, inside sources such as steam from showers and laundry rooms also need to be considered in building design.

The best treatment for moisture build-up is to prevent it from happening by employing good construction practices and maintaining proper ventilation. The Build A Better Home program from APA – *The Engineered Wood Association* is designed to provide builders and homeowners with the construction guidelines they need to protect their homes against damaging moisture infiltration. Key elements in the building envelope are the roof, walls, and foundation. This Better Building Guide addresses design details for roofs.

FIGURE 1
 ROOF SYSTEM COMPONENTS

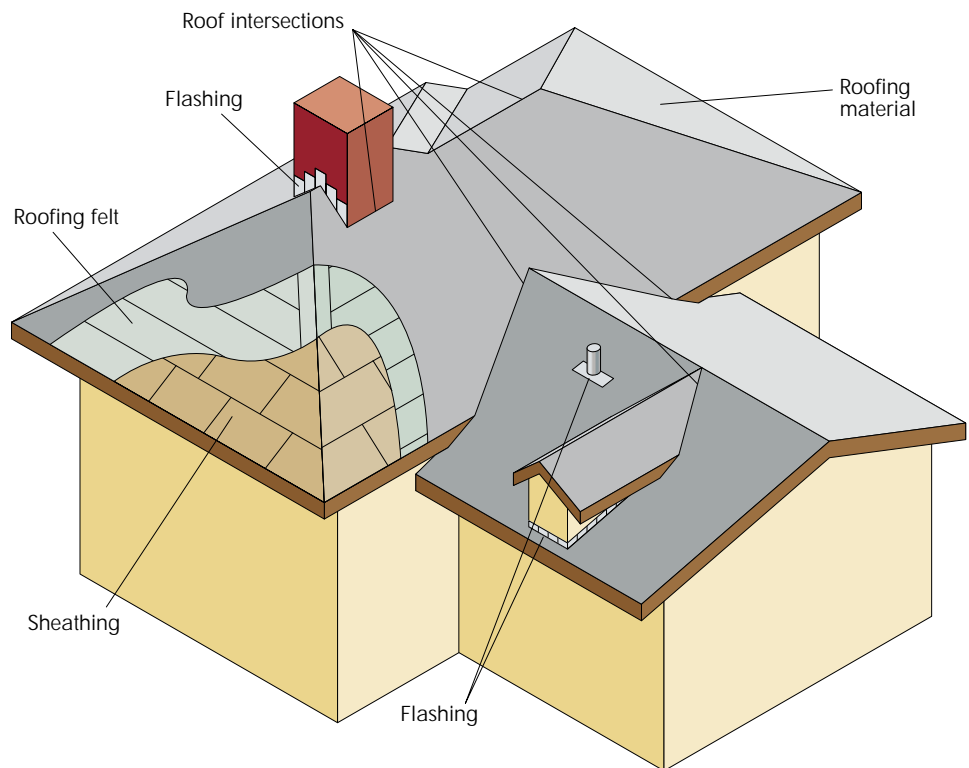

The roof is the first line of defense against the greatest source of unwanted moisture in and around a building: rain. Both the overall design of the roof and the finishing details are important factors in designing a building to withstand moisture penetration. Properly sized roof overhangs protect the siding of the house from all but wind-driven rain, and well-designed gutters discharge rainfall away from the foundation.

A CLOSER LOOK AT ROOF DESIGN

Low-slope and pitched roofs

Roofing systems fall into two categories: near-flat or low-slope roofs, and pitched roofs. Each type uses different waterproofing methods to keep water away from the interior. Pitched roof systems rely on the force of gravity and the surface friction of the roofing materials to direct the flow of water downward and outward. These systems rely on a series of overlapping elements – roofing felts, shingles, tiles, and flashing details – to redirect rainfall. The pitch of the roof provides the gravity and the detailing provides the redirection.

In low-slope roofing systems, water is kept outside of the building envelope by providing a perfect waterproofing barrier over the entire roof system and around every penetration in that roof. Instead of providing the redirecting force to channel water away from the inside of the building envelope, the force of gravity drives the water into every imperfection in the waterproofing system. Moderately high winds can force water to collect in areas that would normally drain adequately. Once standing water is present, even minor defects can cause major water leaks.

TABLE 1

RECOMMENDED MINIMUM FASTENING SCHEDULE FOR APA PANEL ROOF SHEATHING (Increased nail schedules may be required in high wind zones.)

Panel Thickness ^(b) (in.)	Size ^(c)	Nailing ^(a)	
		Maximum Spacing (in.)	
		Supported Panel Edges ^(d)	Intermediate
5/16 - 1	8d	6	12 ^(e)
1-1/8	8d or 10d	6	12 ^(e)

(a) Other code-approved fasteners may be used.

(b) For stapling asphalt shingles to 5/16-inch and thicker panels, use staples with a 15/16-inch minimum crown width and a 1-inch leg length. Space according to shingle manufacturer's recommendations.

(c) Use common smooth or deformed shank nails with panels to 1 inch thick. For 1-1/8-inch panels, use 8d ring- or screw-shank or 10d common smooth-shank nails.

(d) Fasteners shall be located 3/8 inch from panel edges.

(e) For spans 48 inches or greater, space nails 6 inches at all supports.

The roofing system, whether pitched or low-slope, is made up of a number of different components: roof sheathing, underlayment, roofing material, roof intersections, flashing details, and ventilation. Each of these components must be correctly installed for the system to work as designed. (Figure 1)

Roof Sheathing

Roof sheathing is attached to the roof framing, trusses, or rafters, and provides the nail base for the other components of the roofing system. Follow the recommended nailing schedules (Table 1) for attaching sheathing to the framing, and install panels as shown in Figure 2.

In addition to performing as the structural base for the roofing system, the sheathing is an important part of the overall building frame, transferring water, snow, wind, and construction loads into the structural frame below. This is true for both pitched and low-slope roofs. The most common sheathing materials used in residential and light commercial roofs are wood structural panels, such as APA Rated Sheathing.

FIGURE 2

INSTALLATION OF APA WOOD STRUCTURAL PANEL ROOF SHEATHING

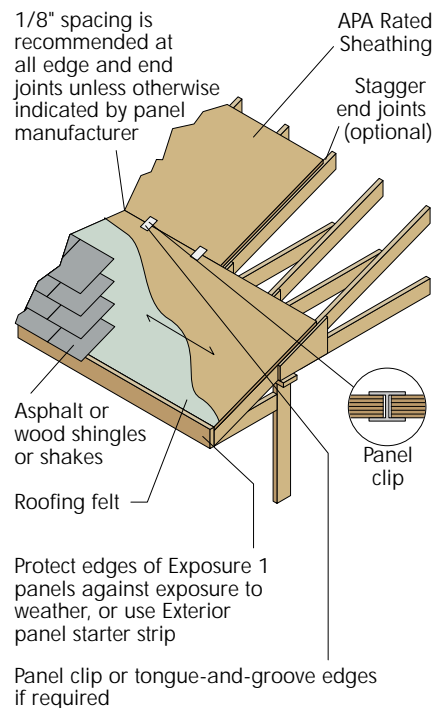

Roofing Underlayment

Roofing underlayment, often made of building paper or “felt”, is the first weatherproofing layer for a pitched roof. Underlayment should be installed from the bottom of the pitched roof to the top, such that each upper layer overlaps the lower layer. If any water leaks through the roofing materials, the underlayment provides a path along the top of the paper to the edge of the roof. See Figures 3A through 3C for examples of proper underlayment installation. Note that the underlayment is always installed in such a way as to channel the water out and down, away from the wood structural panel sheathing below.

On low-slope roofs, the underlayment, if used, can perform a number of different functions depending on the type of roofing that is applied over it. Unless used as a part of the “roofing material,” these functions are not water-protection related. In some systems the underlayment is attached mechanically to the roof sheathing and the roofing material is adhered to the underlayment. In this case it has the mechanical function to hold down the roofing material. If a leak forms in the roofing, the underlayment provides little protection because of the fastener penetrations.

Finished Roofing Materials

Roofing material, the visible finished layer on a roof, provides the primary waterproof barrier for the structure. Because the roof surface is subjected to extremes of heat and cold, rain, snow, hail, flying debris, ultraviolet light, and

FIGURE 3A

TYPICAL SINGLE-LAYER UNDERLAYMENT INSTALLATION FOR STEEP SLOPE ROOFS

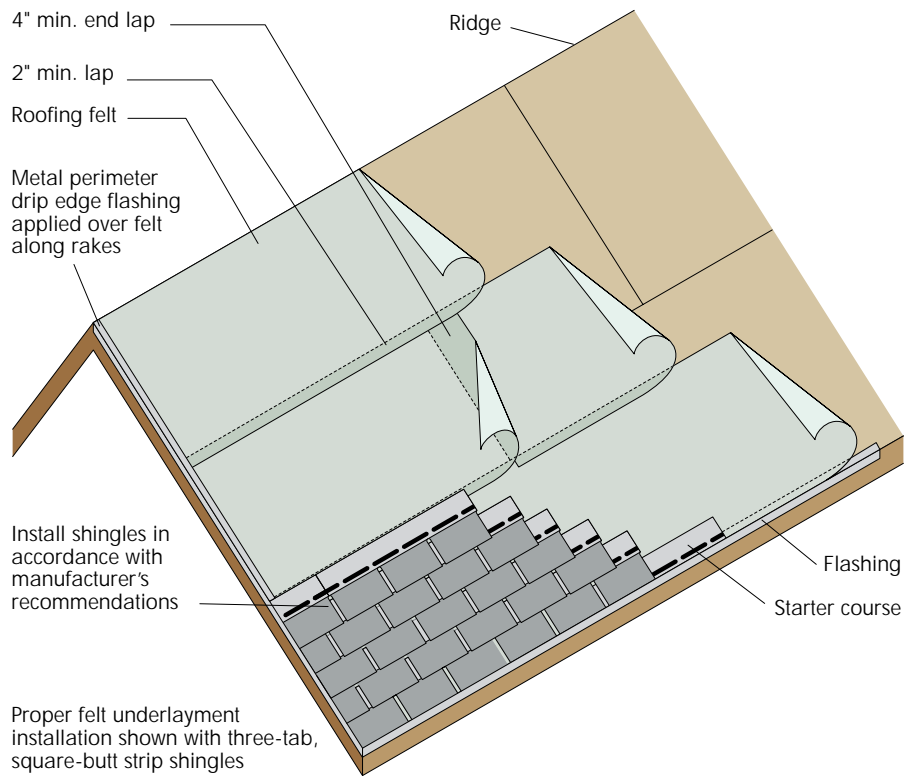

foot traffic of maintenance personnel, the roofing material must have additional durability-related properties in addition to those required for keeping water out of the structure's envelope.

For pitched roofs, almost all roofing materials rely on some form of shingling to provide the weatherproof barrier. Like the underlayment, these roofs are installed from the bottom-up, with successive layers overlapping, both vertically and horizontally. Asphalt shingles are most common, but other materials include slate, clay and concrete tiles, wood shingles and shakes,

or metal shingles. Standing seam and corrugated metal roofs are often made up of one piece elements that are full length from the ridge to the overhang. Adjacent panels are connected to one another with a folded standing seam – the seam is elevated above the surface of the roof – or by overlapping adjacent corrugations.

Low-slope roofs use many different proprietary and non-proprietary systems ranging from single to multiple ply; adhered, mechanically anchored, or ballasted; hot mopped or cold applied (solvent, urethane or epoxy based)

systems; rolled on or poured on; vented or unvented; or any combination thereof. For installation recommendations, refer to Volume 1 of the NRCA Roofing and Waterproofing Manual, Fourth Edition, available from the National Roofing Contractors Association (NRCA) 10255 W. Higgins Road, Suite 600 Rosemont, Illinois 60018-5607, (847) 299-9070, (847) 299-1183. Information is also available from the following:

ASPHALT ROOFING MANUFACTURERS ASSOCIATION (ARMA)
 4041 Powder Mill Road
 Suite 404
 Calverton, Maryland 20705-3106
 (301) 231-9050
 (301) 881-6572 (fax)

NATIONAL TILE ROOFING MANUFACTURERS ASSOCIATION, INC.
 P.O. Box 40337
 Eugene, Oregon 97404-0049
 (541) 689-0366
 (541) 689-5530

CEDAR SHAKE AND SHINGLE BUREAU
 P.O. Box 1178
 Sumas, Washington 98295-1178
 (604) 462-8961

METAL CONSTRUCTION ASSOCIATION
 104 S. Michigan Ave. Suite 1500
 Chicago, Illinois 60603
 (312) 201-0193

SINGLE-PLY ROOFING INSTITUTE (SPRI)
 200 Reservoir Street, Suite 309-a
 Needham Heights, Massachusetts 02494
 (781) 444-0242

FIGURE 3B
UNDERLAYMENT CENTERED IN VALLEY

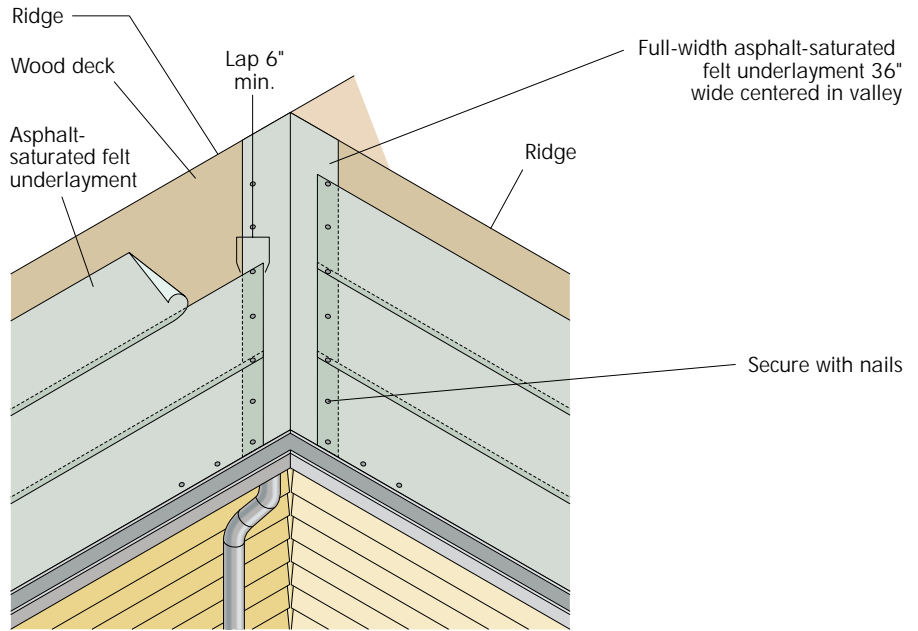
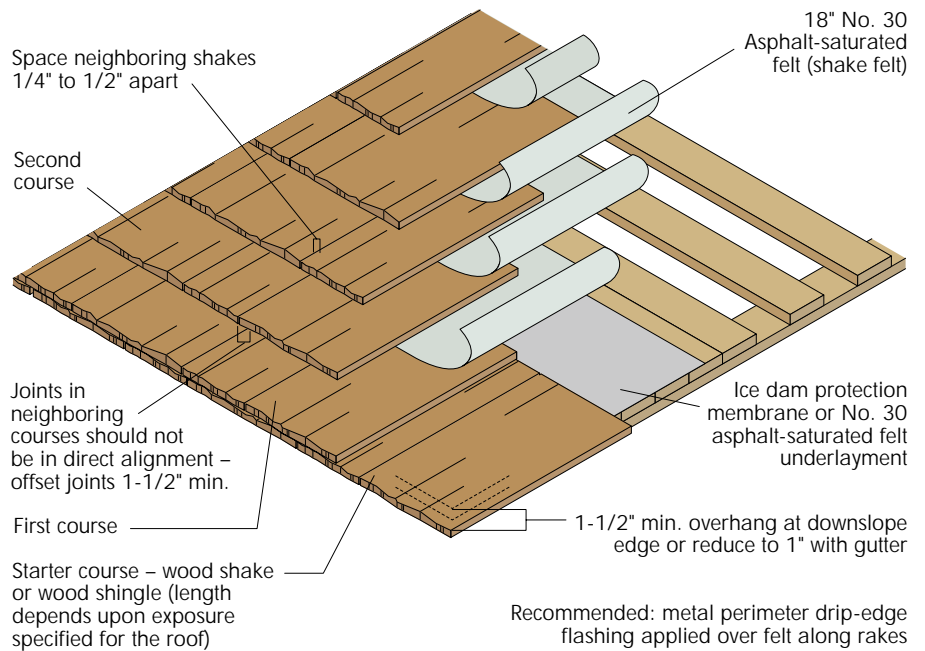

FIGURE 3C
WOOD SHAKE APPLICATION



Roof Intersections

The majority of roof leaks occur in locations where the plane of the roof is interrupted by a ridge, another roof intersecting at an angle, a wall or a penetration. Even the simplest of rooflines has dozens of potential leak sites due to chimneys, skylights, ridges and valleys, utility vent stacks, kitchen and bathroom ventilation fans and code-required roof ventilation penetrations. Proper detailing around these areas is very important in preventing leaks.

Proper detailing of roof intersections:

Figures 4A through 4D illustrate examples of proper roof ridge detailing for asphalt, slate, tile, and shake roofing systems.

FIGURE 4A

SHINGLE ROOF RIDGE DETAILS (starter course details also shown)

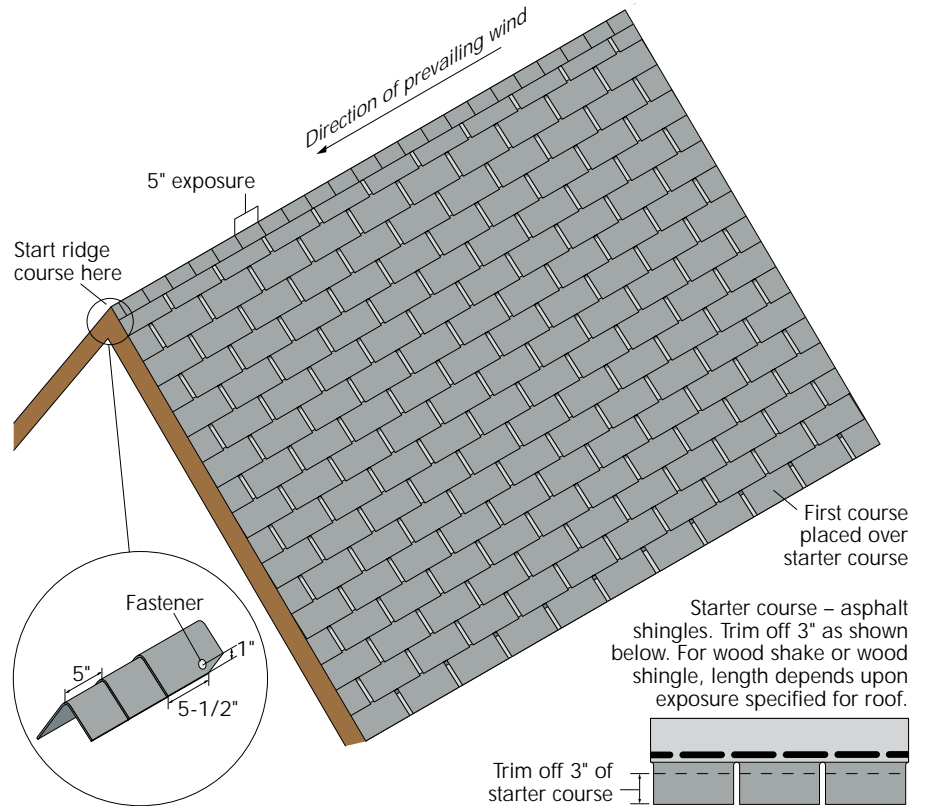

FIGURE 4B

SLATE ROOF RIDGE DETAILS

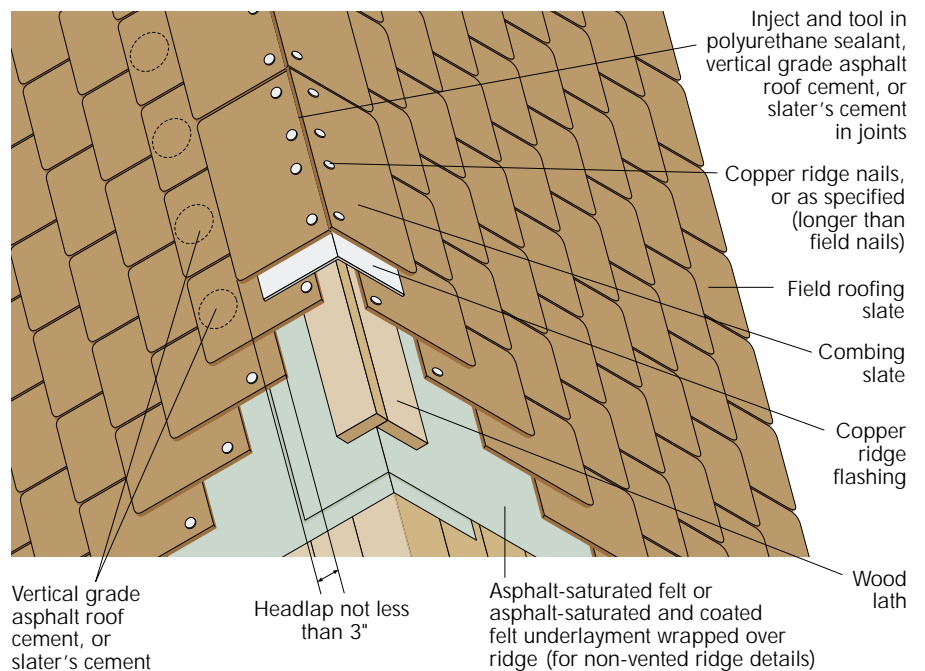
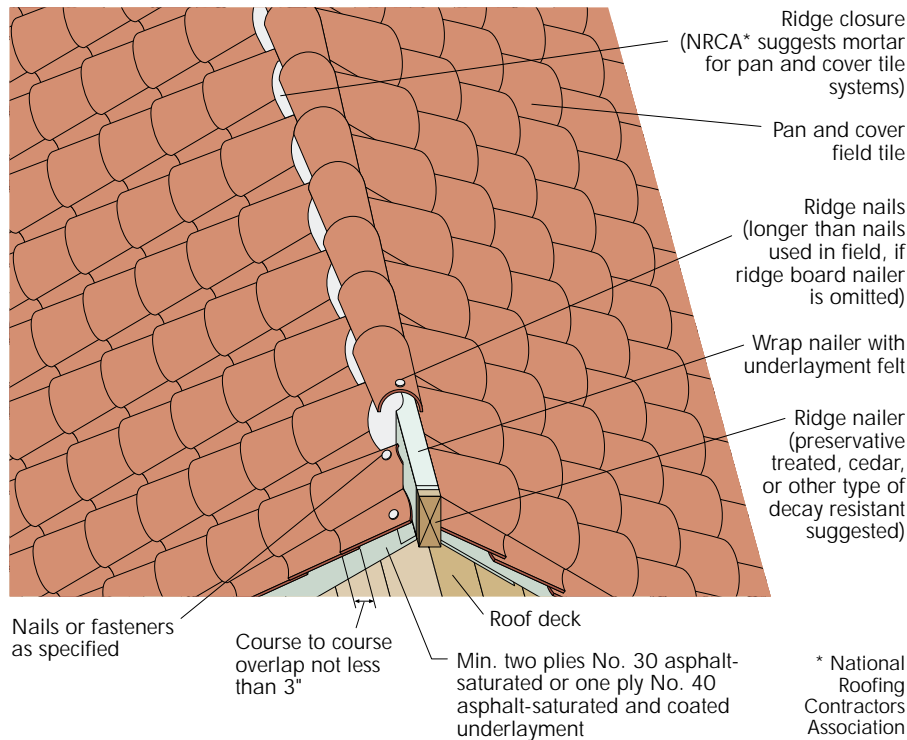

FIGURE 4C

PAN AND COVER TILE ROOF RIDGE DETAIL



Figures 5A through 5D illustrate typical valley intersection details. Figure 5A shows an example of an open metal valley flashing suitable for all roofing types and Figure 5B shows closed mitered valley flashing for use with flat roofing materials such as slate or flat tile. A closed mitered valley should not be used with a wood roof if leaves or needles can be an impediment to rapid water runoff. Figures 5C and 5D are examples of common valley details for asphalt shingles.

FIGURE 4D

WOOD RIDGE DETAIL FOR USE WITH SHAKE- OR SHINGLE-TYPE ROOF

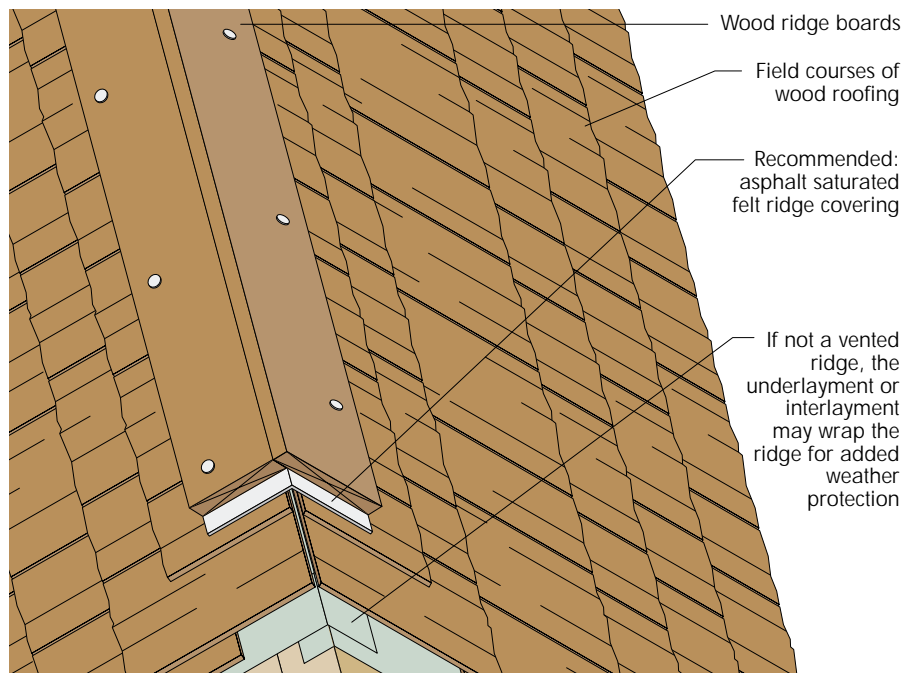

FIGURE 5A

TYPICAL METAL OPEN VALLEY FLASHING

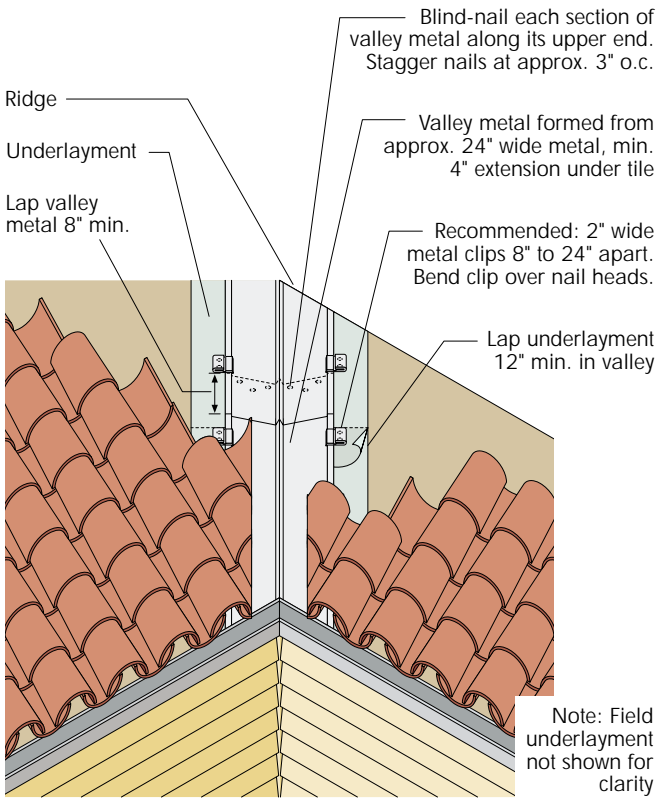

FIGURE 5C

USE OF ROLLED ROOFING MATERIAL FOR OPEN VALLEY CONSTRUCTION

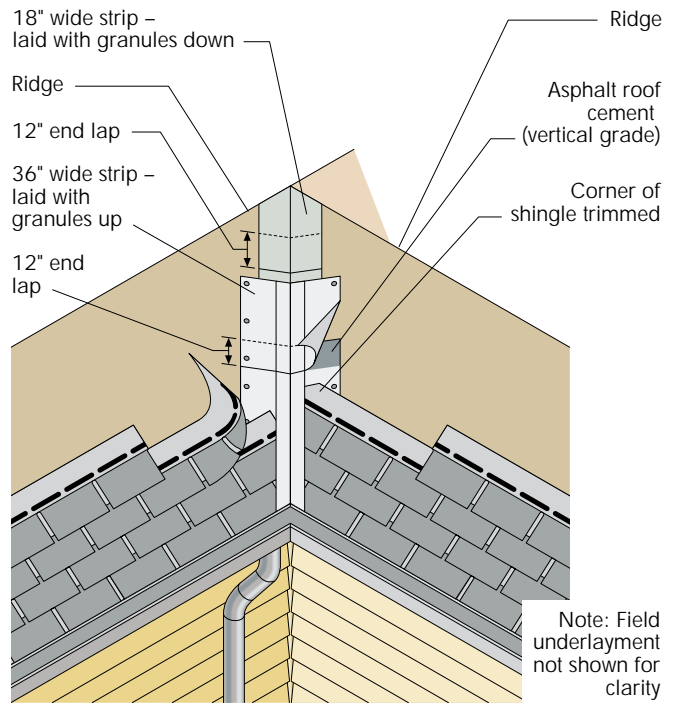

FIGURE 5B

CLOSED MITERED VALLEY WITH INTERWOVEN METAL VALLEY FLASHING – SHOWN WITH FLAT TILE OR SLATE ROOFING

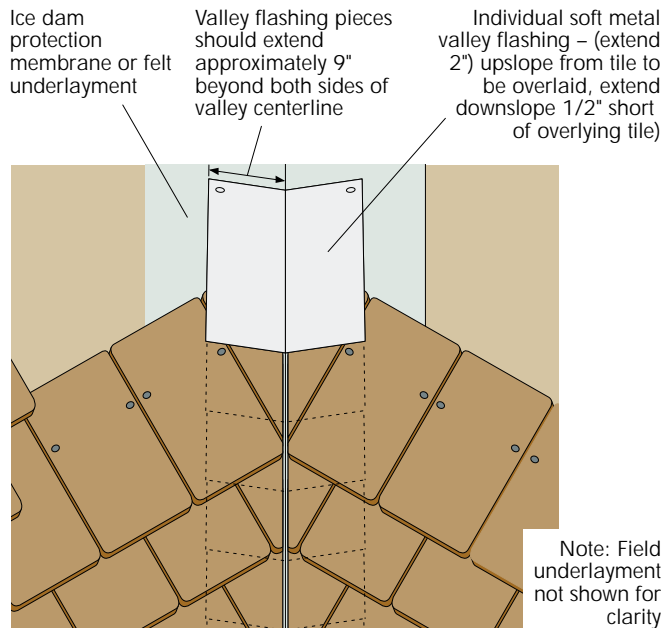
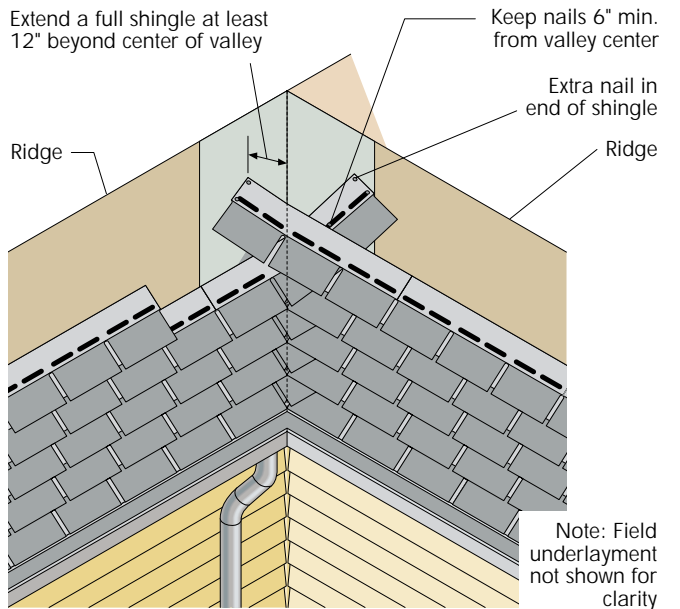

FIGURE 5D

WOVEN VALLEY



Figures 6A through 6C deal with hip roof intersections. Figure 6A illustrates a typical example for flat roof products such as slate or low-profile tile. Figure 6B shows common hip details for asphalt shingles, and Figure 6C illustrates a roof hip made with high-profile tile.

Figure 7 illustrates proper detailing at roof eaves and rakes. Figure 7 provides the most common detail used for eaves and rakes – the use of drip-edge material. Options A and B show common rake details for tile roofs.

FIGURE 6A

MITERED HIP SHOWN WITH SLATE ROOFING AND INTERWOVEN HIP FLASHING

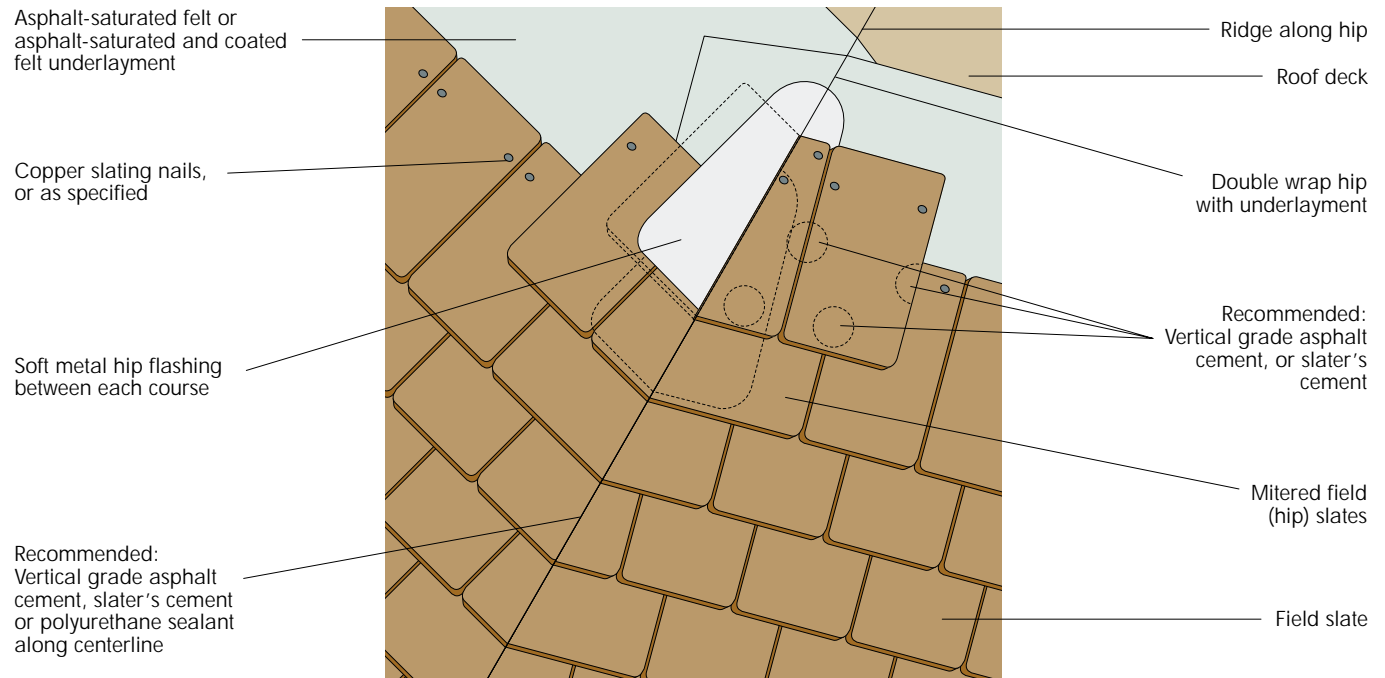

FIGURE 6B

ASPHALT ROOF HIP DETAIL

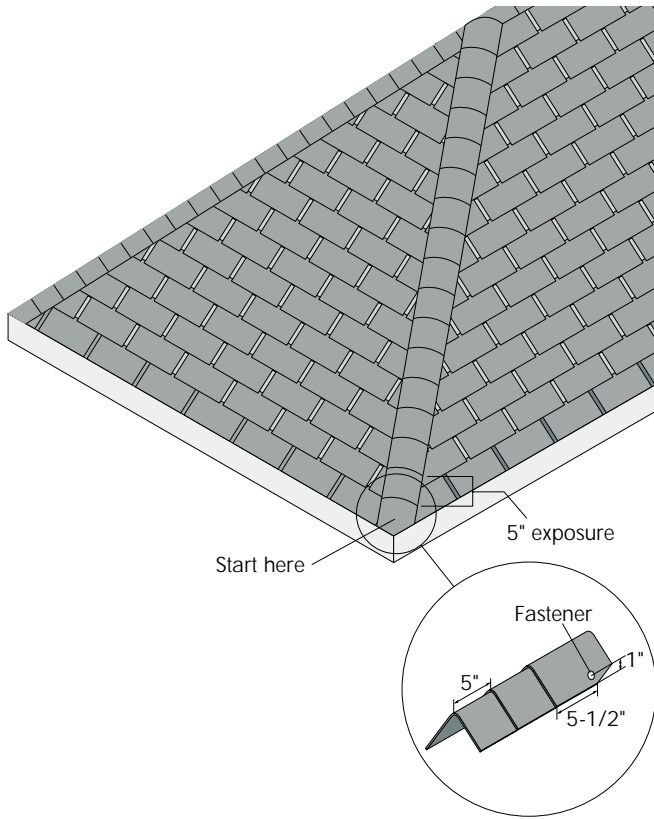

FIGURE 6C

HIP DETAIL FOR CLAY OR CONCRETE TILE

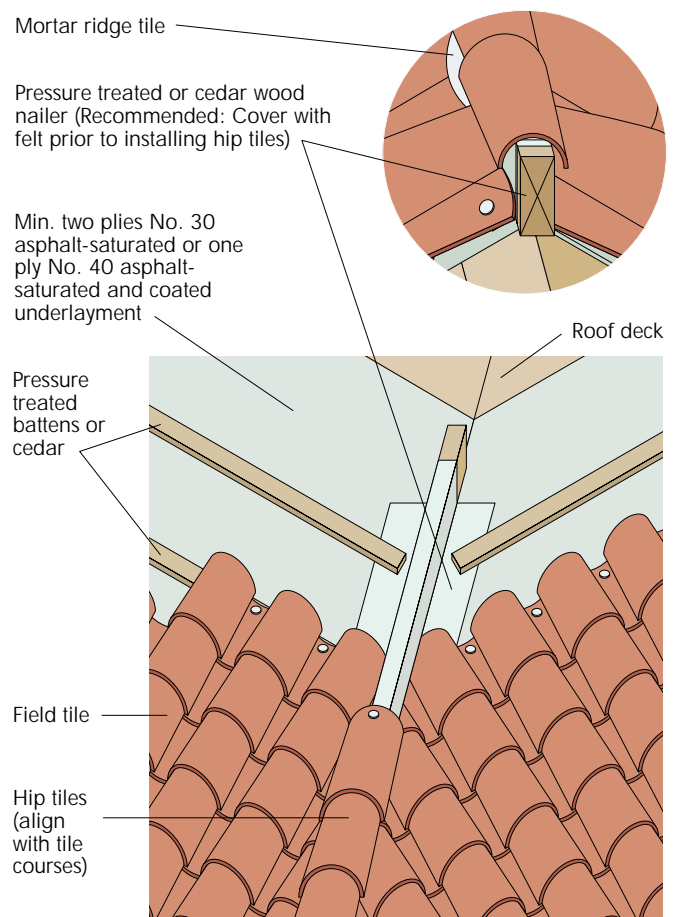
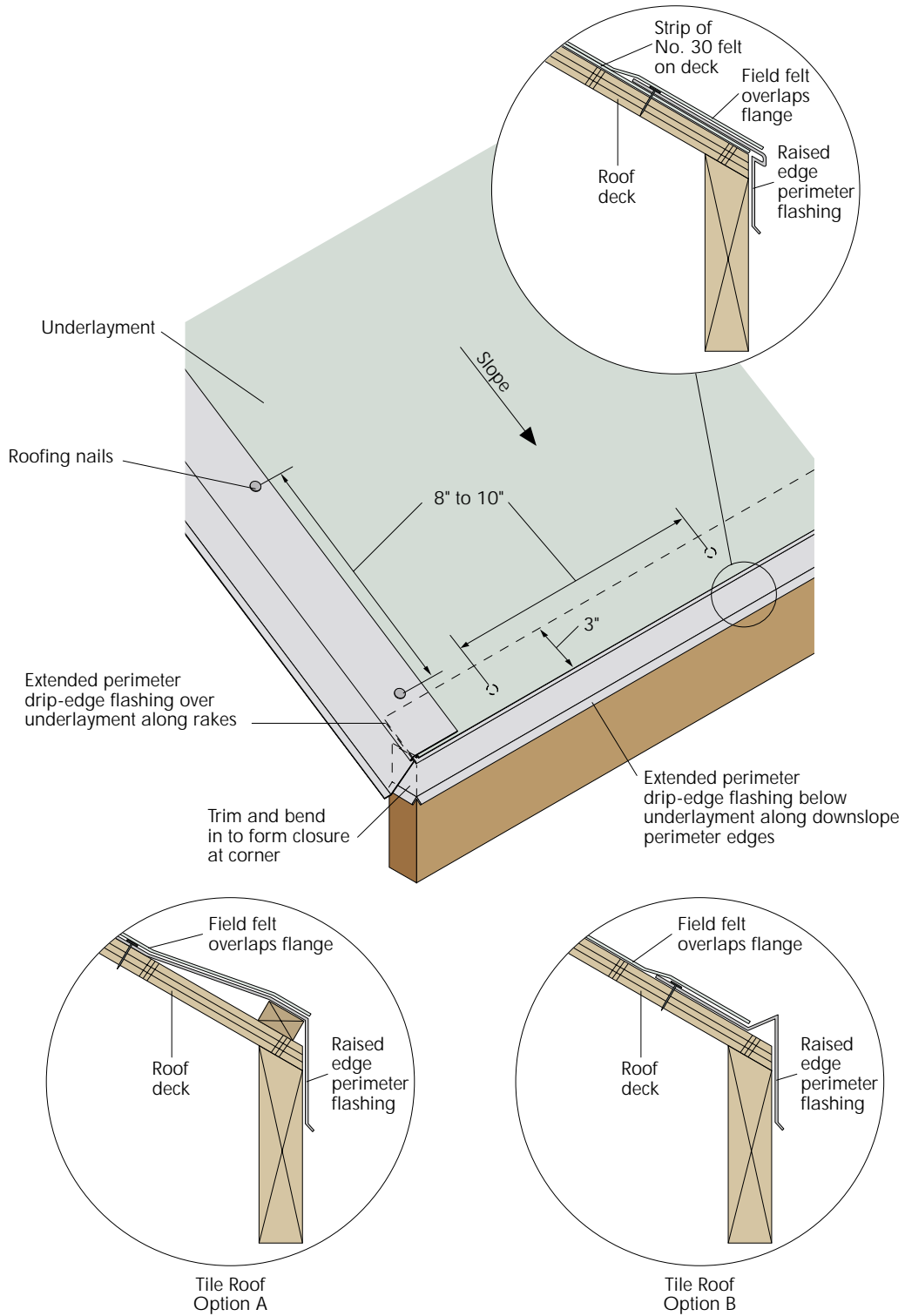

FIGURE 7

EXTENDED DRIP-EDGE METAL FLASHING AT EAVES AND RAKES FOR ROLL ROOFING AND SHINGLES.
OPTIONS A AND B SHOWN FOR TILE ROOF



Flashing Details

Flashing is made up of thin sheets of corrosion resistant material used in conjunction with the other elements of the roof system to prevent leaks around roof intersections and penetrations discussed above. Flashing is normally made up of galvanized steel, copper aluminum, lead or vinyl. Often small roof penetrations such as vent stacks use flanged rubber boots in lieu of more conventional flashing because of the circular shape of the penetration.

In a pitched roof, regardless of the application or the type flashing used, the purpose of the flashing is to direct the flow of the water that leaks into the intersection down and away from the interior of the structure to the topside of the roofing material. In every case shown, the top edge of the flashing passes underneath the underlayment, the upper pieces of flashing pass over the lower pieces, and the lower edge of the flashing always passes over the top of the roofing material. In such a manner, the flashing never directs the flow of water to the bottom side of the underlayment, never putting it in contact with the wood structural panel sheathing.

Proper flashing installation details:

Figure 8 is an illustration of a common vent stack penetration using a rubber or soft metal flashing. While the illustration shows a high-profile tile being used, the general procedure for properly installing the vent pipe flashing is the same for all roofing material types.

A series of illustrations are presented in Figure 9 showing the steps necessary to flash around a masonry chimney. Many of the steps shown are common to other applications in steeply pitched roof applications.

FIGURE 8

TWO-STAGE FLASHING FOR SEALING PLUMBING VENT STACK WITH PAN-AND-COVER TILE ROOF

STEP 1

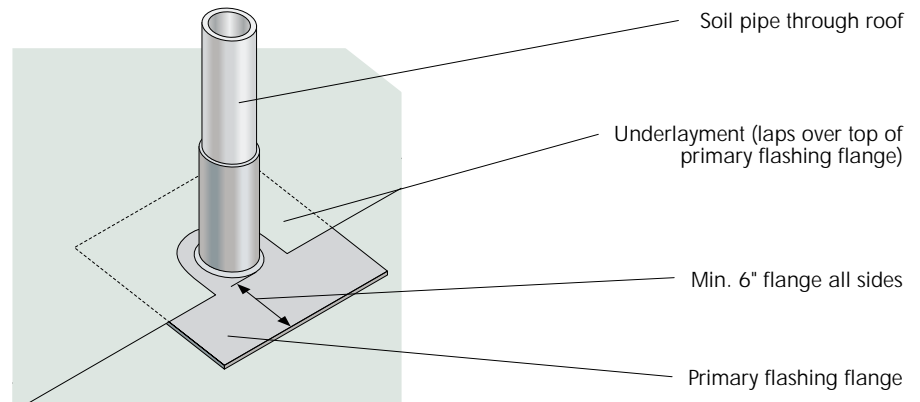

STEP 2

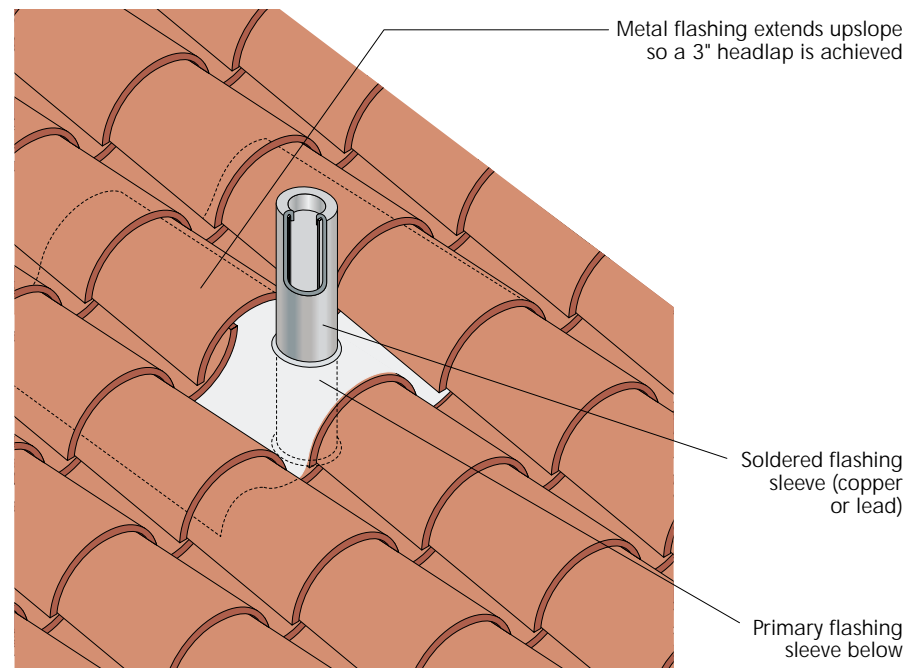

FIGURE 9A

CHIMNEY FLASHING – STEP 1

Wood cricket built on upslope side of chimney. (Recommended if chimney is 24" or wider, or roof slope is 6:12 or greater, or ice or snow accumulation is probable.)

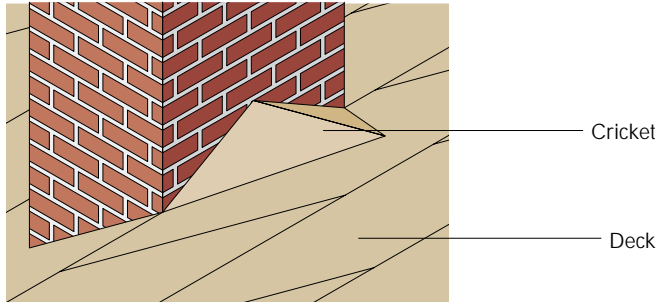

FIGURE 9B

CHIMNEY FLASHING – STEP 2

Apron flashing for downslope portion of masonry chimney. Underlayment shown pulled away from chimney.

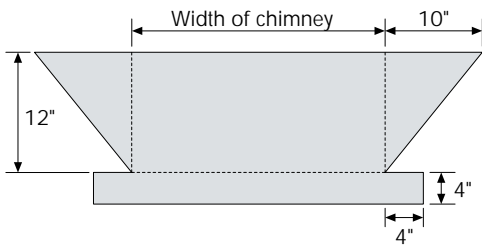
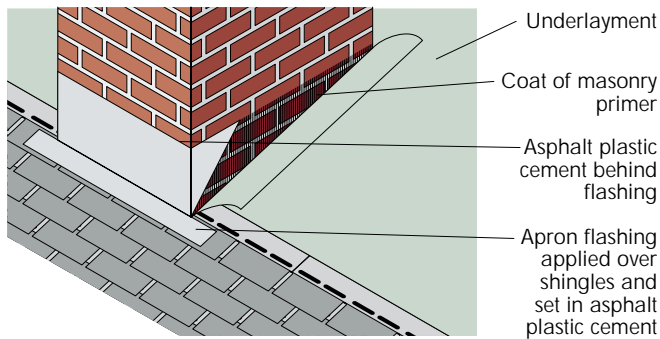

FIGURE 9C

CHIMNEY FLASHING – STEP 3

Interlace step flashing with shingles. Set step flashing in asphalt plastic cement.

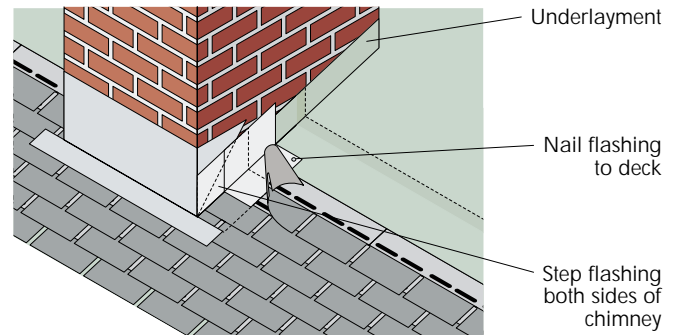

FIGURE 9D

CHIMNEY FLASHING – STEP 4

Extend step flashing up chimney and around corner. Nail corner flashing to deck and cricket.

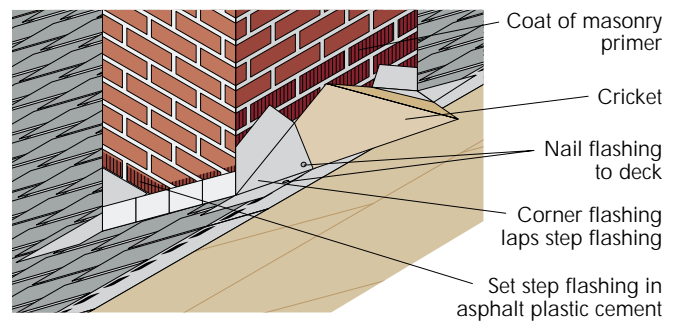

FIGURE 9E

CHIMNEY FLASHING – STEP 5

Place preformed cricket flashing over cricket and corner flashing. Set cricket flashing in asphalt plastic cement.

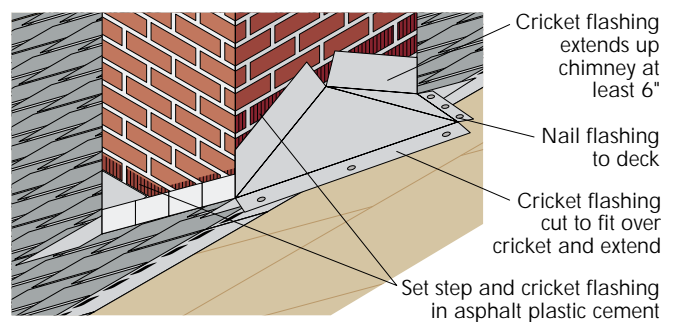

FIGURE 9F

CHIMNEY FLASHING – STEP 6

Flashing strip cut to contour of ridge in cricket. Size to extend up chimney at least 6".

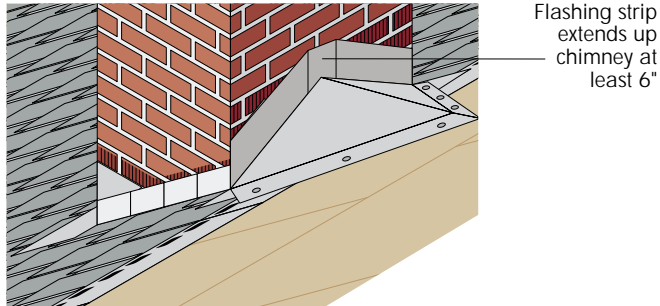

FIGURE 9H

COUNTER FLASHING INSTALLATION ON SLOPE

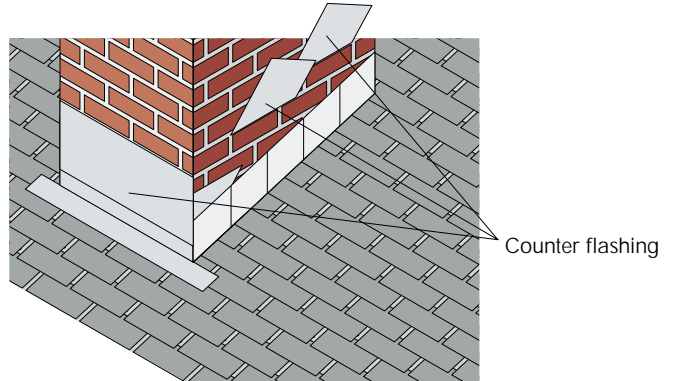

FIGURE 9G

COUNTER FLASHING DETAILS

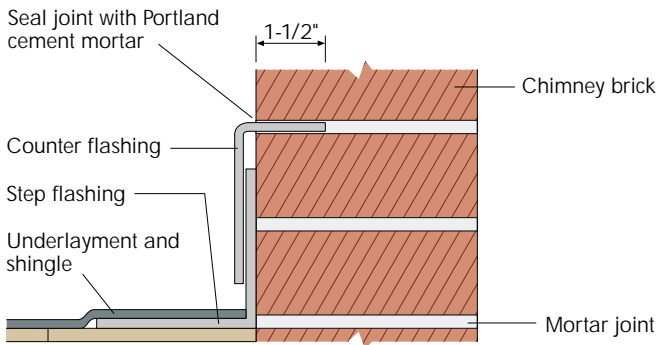
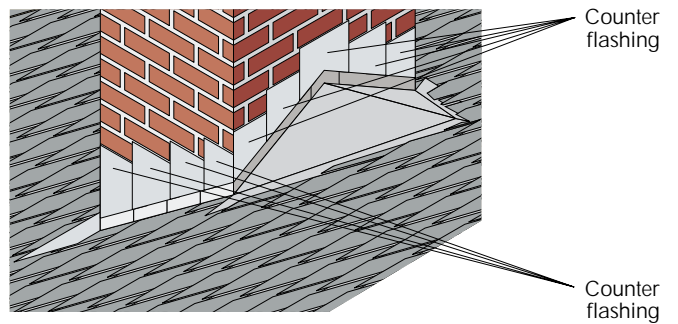

FIGURE 9I

CHIMNEY FLASHING – STEP 7

Place counter flashing over step and cricket flashing. Shingle remainder of roof.



Figures 10A and 10B illustrate the flashing details around a skylight or other similar applications. An example of a typical installation for low-profile roofing such as flat tile, slate, asphalt shingles, or wood shingles is provided as well as one showing such an installation with high-profile clay tile.

The flashing required in intersections between roofing elements and vertical walls immediately adjacent are shown in Figures 11A through 11C.

FIGURE 10A

FLASHING AROUND SKYLIGHT WITH SHINGLE-TYPE FLAT ROOFING

Backer flashing extends upslope under shingles a min. of 3 courses. (Where deemed necessary hold shingles up 1 course and nail high, depending upon anticipated debris and/or snow accumulation.)

Counter flashing laps over step flashing approx. 2" min.

Skylight
 Integral counter flashing with hemmed drip-edge
 Apron flashing with lower edge hemmed under
 Raised curb (2"x8" suggested as min. to attain flashing clearances). Underlayment turned up curb

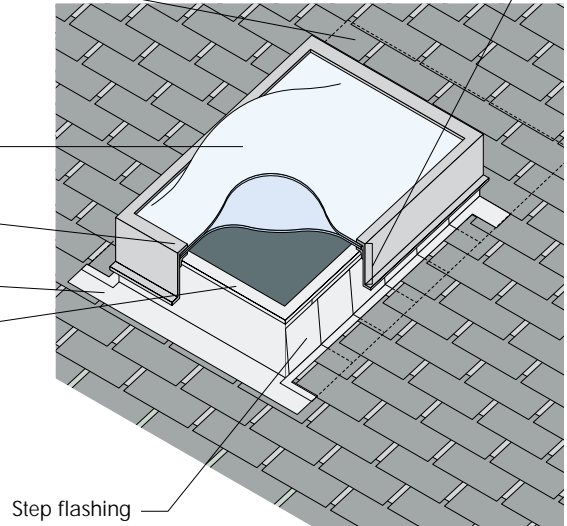

FIGURE 10B

FLASHING AROUND SKYLIGHT - COVER AND PAN CONCRETE/CLAY ROOFING TILE

Backer flashing extends upslope under tile approx. 24". (Where deemed necessary hold tile up 1 course, depending upon anticipated debris and/or snow accumulation.)

Skylight
 Integral counter flashing with hemmed drip-edge
 Raised curb 2"x8" (suggested as min. to attain flashing clearances)
 Apron flashing formed to fit over tiles

Optional: Secondary flashing or counter flashing skirt
 Primary flashing

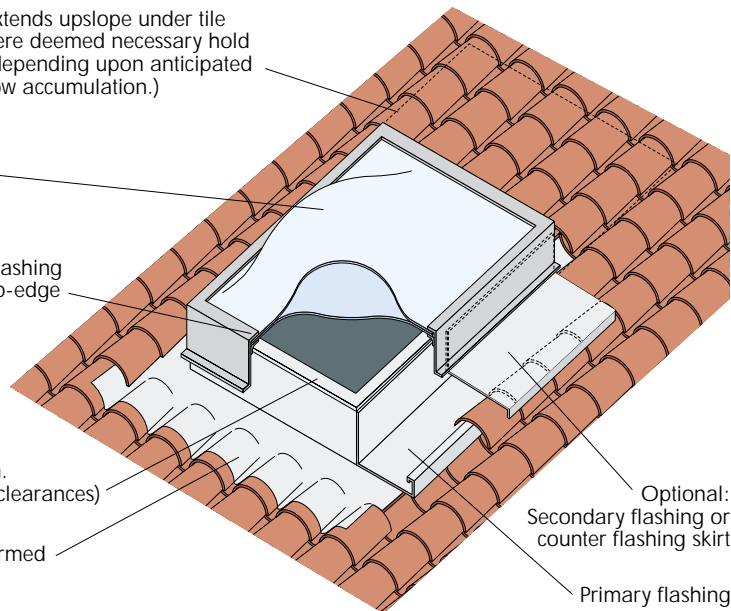

FIGURE 11A

A SHINGLE-TYPE ROOF AT A SLOPED WALL-TO-ROOF INTERSECTION

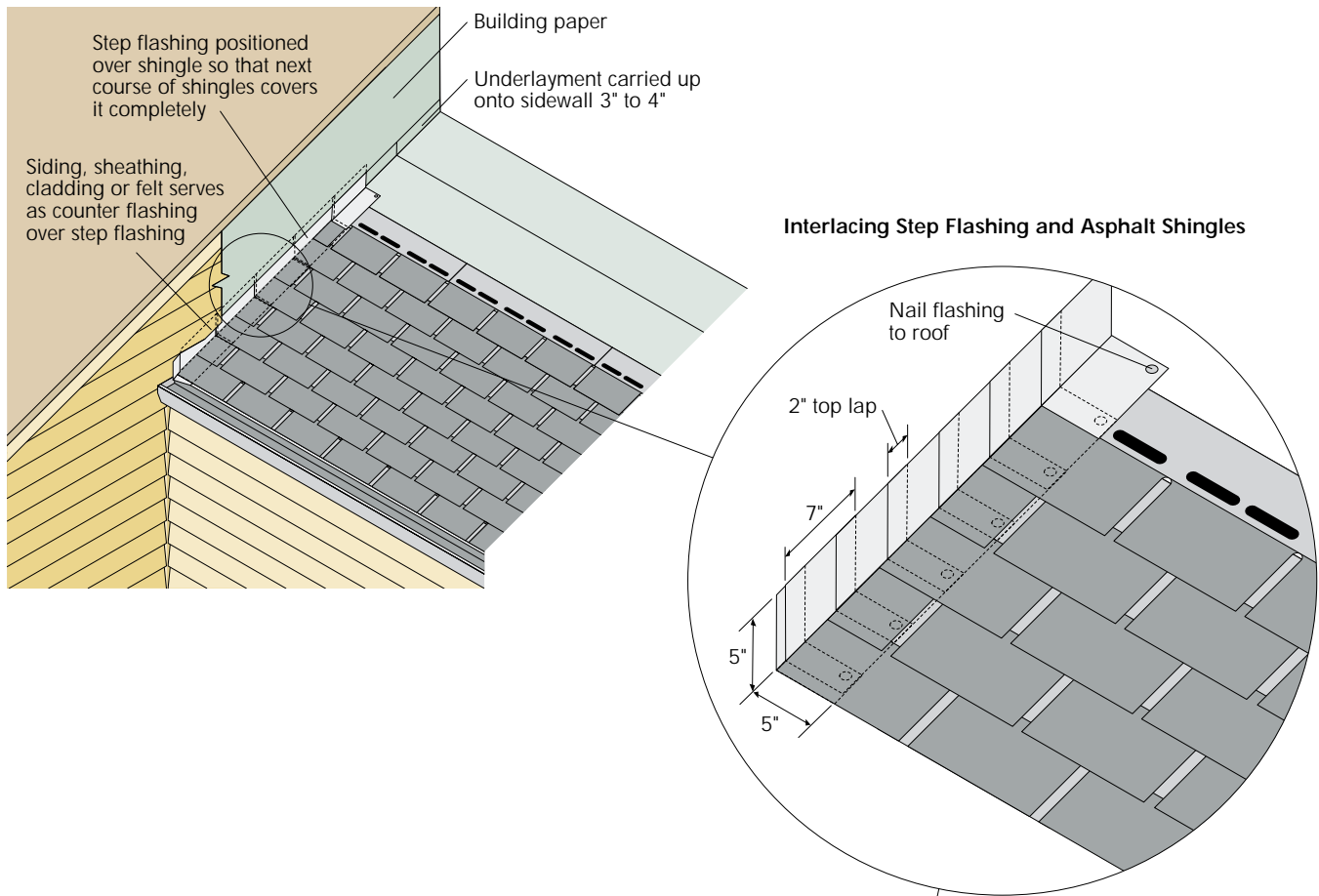

FIGURE 11B

CLOSE UP OF FLASHING DETAIL

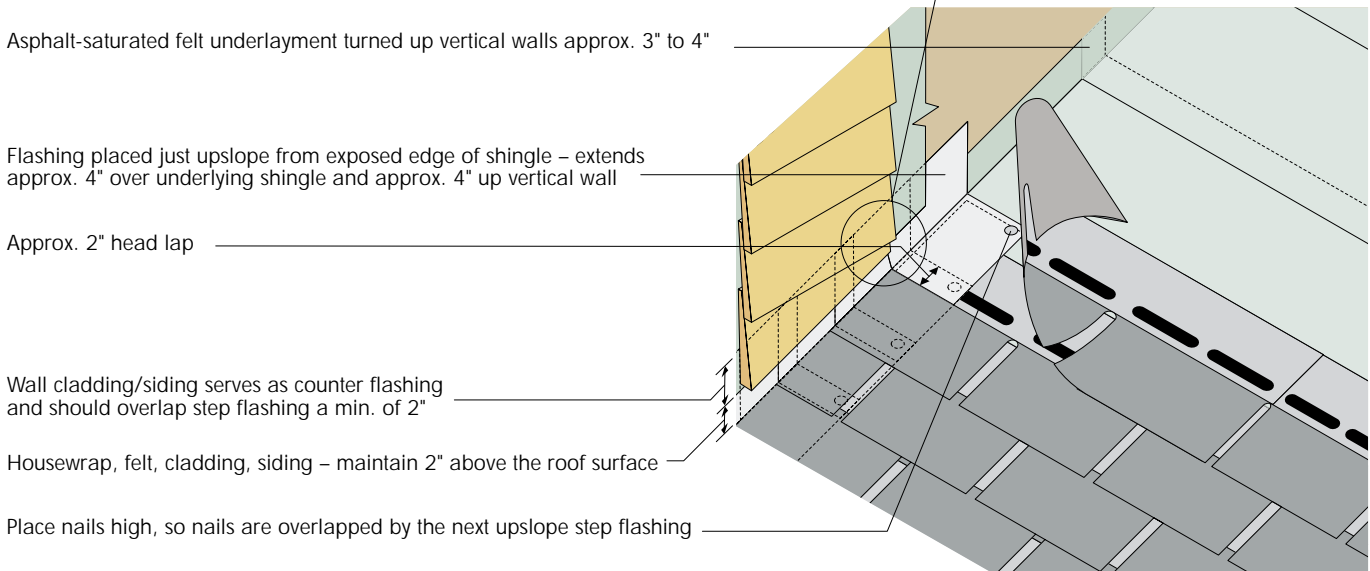
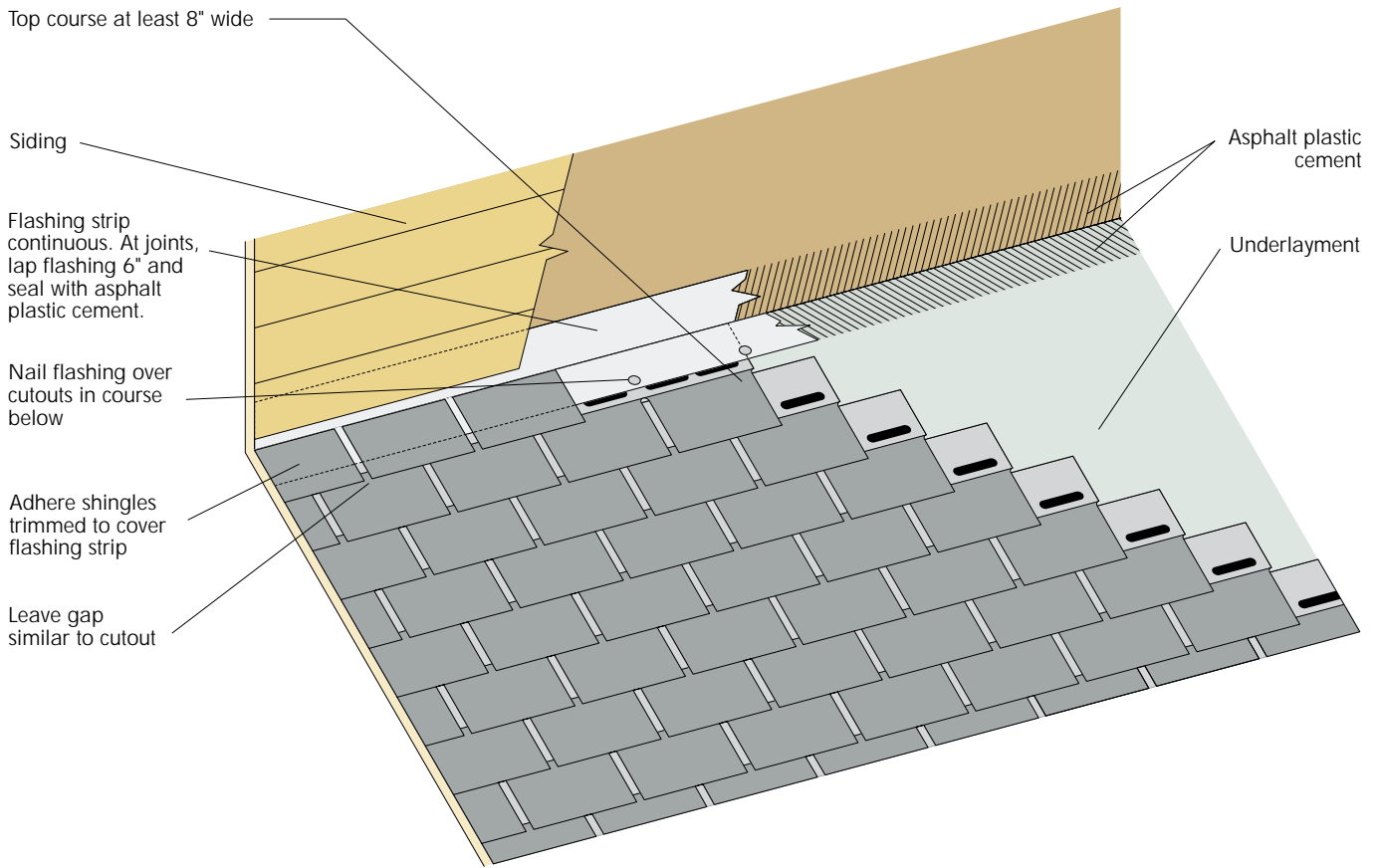

FIGURE 11C

A SHINGLE-TYPE ROOF AT A HORIZONTAL WALL-TO-ROOF INTERSECTION



Ventilation

The purpose of each component of the roof system discussed so far has been to keep water from penetrating the building envelope. During the life of the roof system, it is normal for some leakage to occur, whether by natural deterioration of the roofing material, wind driven rain, ice dams, or damage due to natural events such as wind storms. A little leakage onto the wood structural panel sheathing in most cases can be tolerated because of the code-required ventilation underneath the roof sheathing.

The required ventilation serves two purposes. One is to provide a passage for air flow over the lower surface of the sheathing to promote drying if the panel gets wet from leaks or condensation. Since wood structural panels are manufactured with a fully waterproof adhesive, they can tolerate the kind of wetting and drying associated with very minor roof leaks. Problems occur when the leaks are great enough that the ventilation is insufficient to dry out the sheathing between wettings. In such cases, the wood sheathing is susceptible to decay.

The second benefit of ventilation is that it lowers the temperature of the roof deck in the summer. High roof-deck temperatures can adversely impact the useful life of some types of fiberglass asphalt shingles. The flow of air on the underside of the sheathing can reduce the temperature of the shingles by 20 to 30 degrees.

Figure 12 illustrates roof ventilation in a steep sloped roof.

FIGURE 12

CODE-REQUIRED ROOF VENTILATION – AT CATHEDRAL CEILING AND ATTIC – UTILIZING CONTINUOUS RIDGE VENTS

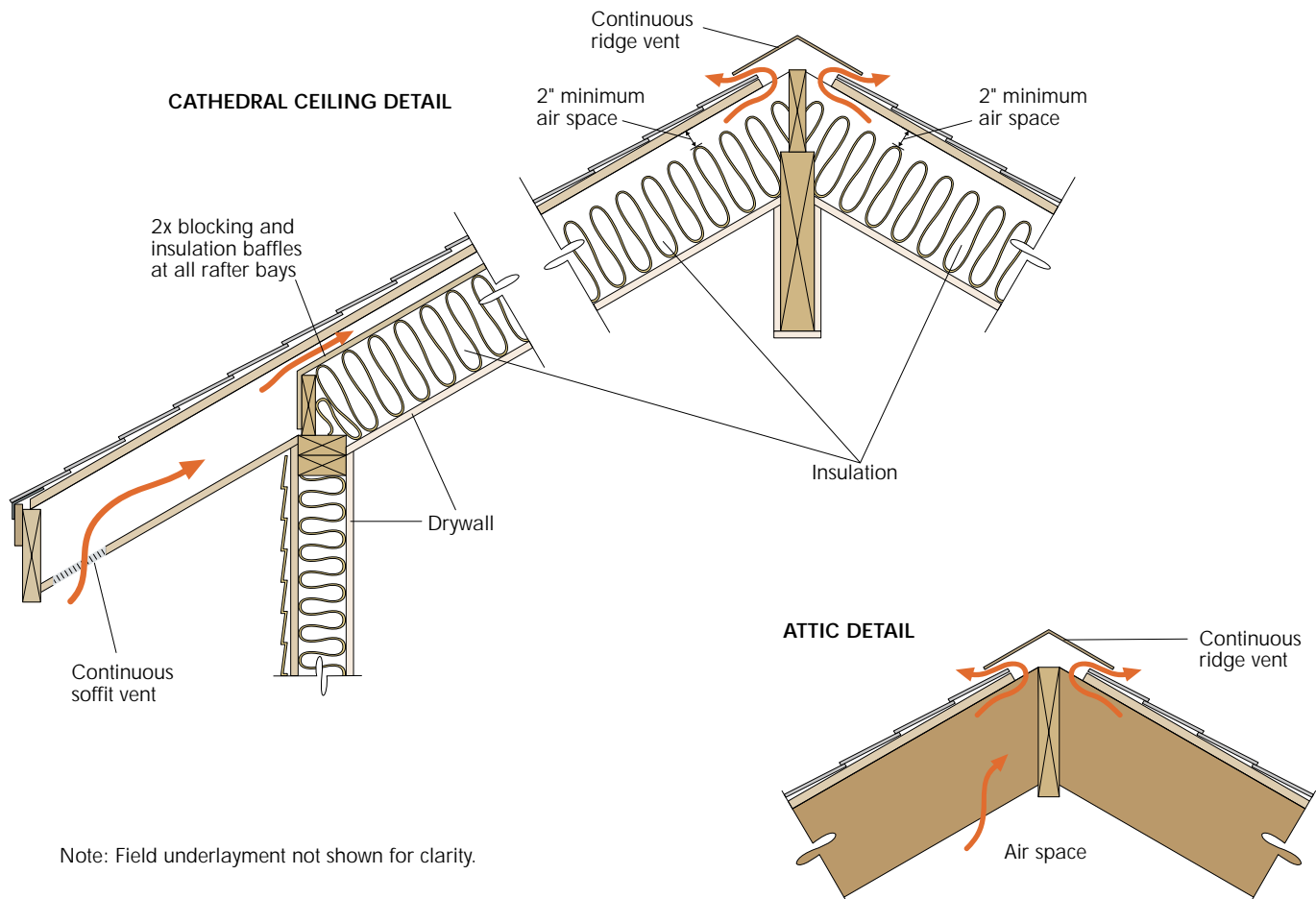

SPECIAL CONSIDERATIONS

Ice Dams: Ice dams are caused when natural heat losses through the roof cause the snow to melt. The melt water flows downward until it hits the roof overhang and then refreezes because this area of the roof is at ambient temperature. Given the right set of circumstances, this layer of ice in the roofing material can get thicker and thicker. Eventually, the melt water will pond up behind the ice dam and start backing up the roof slope. As the water backs up it moves up behind the shingles and, if improperly applied, even the underlayment. This can saturate the wood structural panel sheathing and cause leaks. Figure 13A shows an example of proper detailing to mitigate the ice dam problem through the use of a double layer of roofing felt underlayment and Figure 13B shows the use of self-adhering underlayment for the same application. Resistance heaters are installed in some locations where the problem is especially severe.

FIGURE 13A

SEALED ASPHALT SATURATED FELT UNDERLAYMENT USED IN LOW SLOPE ROOFS OR USED IN AREAS OF WIND DRIVEN RAIN, SNOW OR WHERE ICE DAMS ARE PREVALENT

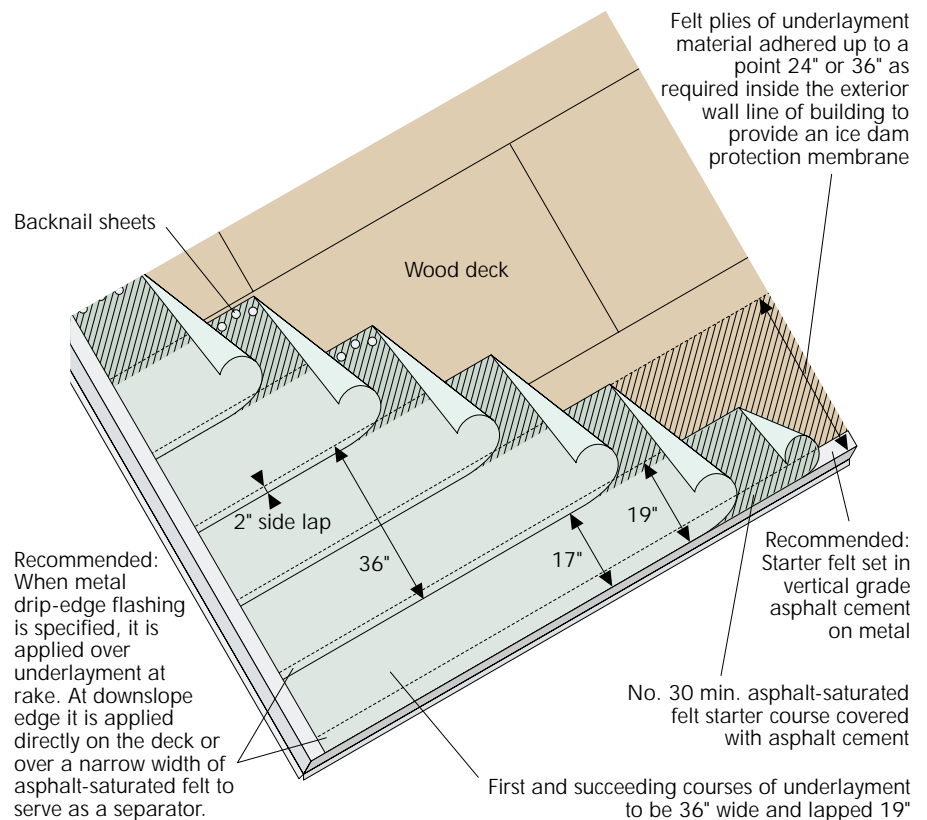

WHERE DOES ALL THE WATER COME FROM?

There are three primary sources of water in residential construction. In order of magnitude from the greatest to the least are leakage, infiltration, and vapor transmission.

LEAKAGE is the greatest contributor to water damage in the United States. Caused by improperly installed flashing and roofing details, even small leaks can introduce tens of gallons of water into the structural shell of the building over a relatively short period of time. Every year millions of dollars of damage are caused by leaks.

INFILTRATION is the transportation of water into the structural system of a building by differential air pressure. The differential pressure between the inside and the outside of a structure draws moisture laden air into the cavities between

inside and outside walls and between ceilings and roof surfaces. The differential pressures can be caused by the stack effect (warm air rises, pulling in cold air from the outside), improperly vented heating equipment, unbalanced ventilation systems, or high wind. All of the little gaps in an average home envelope add up to over one square foot, which means that even a slight differential pressure can cause a lot of air movement.

Problems with air infiltration arise when hot moist air infiltrates into a roof or wall cavity and impinges on a cold surface. If that surface is cold enough to lower the temperature of the air to below its dew point, water will condense on the cool surface. The warm moist air can come from the outside – an air-conditioned home in Miami in the summer – or from the inside – a home in Wisconsin in the winter. The water always ends up in the same place – inside the wall or roof cavity. Fortunately the ventilation required of the roof cavity has a

FIGURE 13B

ASPHALT SATURATED FELT UNDERLAYMENT USED IN CONJUNCTION WITH AN ICE DAM PROTECTING MEMBRANE

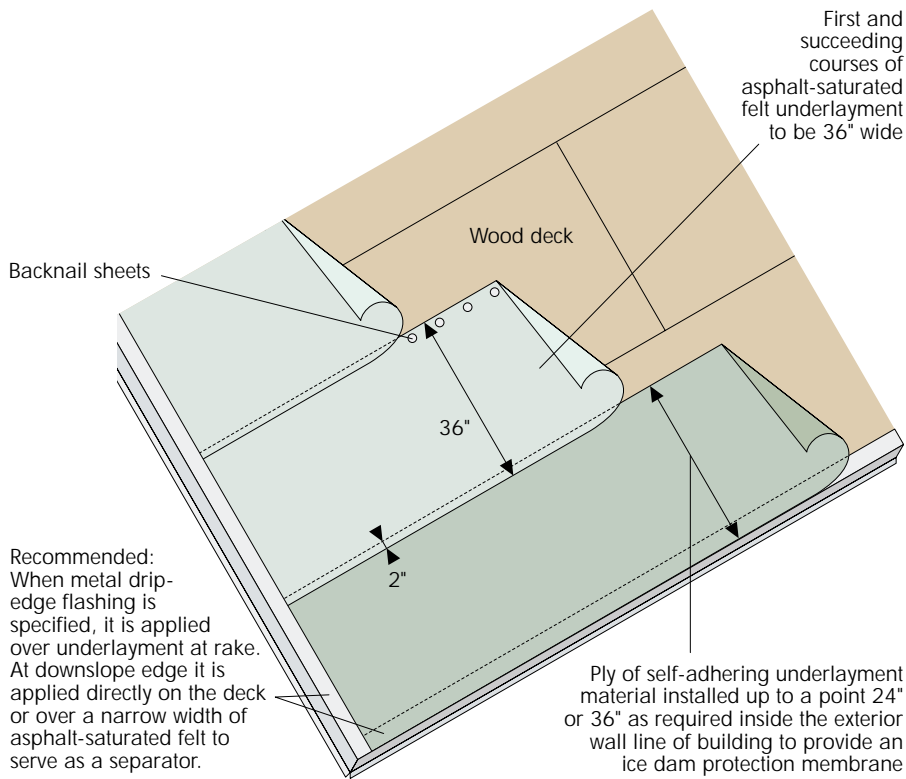

proven track record of good performance except in the most extreme situations. In walls, the use of an air barrier is the most effective way to control infiltration.

VAPOR TRANSMISSION is the passage of molecular water, "vapor," through an "obstacle" driven by a differential partial pressure for water across the obstacle. It carries moisture from the wet side of a roof or wall to the dry side. Since this usually doesn't involve a large volume of water, the proper placement of a vapor retarder – on the warm side – will normally provide all of the protection required. Sloppy penetrations in the vapor retarder for switch boxes, plumbing connections, and around windows and doors do not have an appreciable impact on the vapor transmission. They can, however, cause problems due to air infiltration at those points. Most of the damage associated with improperly installed vapor retarders is actually caused by air infiltration.

Vapor transmission problems are more severe with low-slope roofs because of the difficulty in providing ventilation behind the sheathing. This lack of slope means that the stack effect is less successful in providing ventilation for the sheathing. The designer must use calculation or computer modeling to determine whether a vapor retarder is necessary in low-slope roofs. As an alternative, a vapor retarder should be considered based on the following conditions:

1. The outside average January temperature is below 40 degrees F (4 degrees C), and
2. The expected interior winter relative humidity is 45% or greater. (Excerpted from the NRCA Roofing and Waterproofing Manual – Fourth Edition)

ADDITIONAL INFORMATION

About APA – The Engineered Wood Association

APA – The Engineered Wood Association is a nonprofit trade association whose member mills produce approximately 60 percent of the structural wood panel products manufactured in North America.

The Association's trademark appears only on products manufactured by member mills and is the manufacturer's assurance that the product conforms to the standard shown on the trademark. That standard may be an APA performance standard, the Voluntary Product Standard PS 1-95 for Construction and Industrial Plywood, or Voluntary Product Standard PS 2-92, *Performance Standards for Wood-Based Structural-Use Panels*. Panel quality of all APA trademarked products is subject to verification through an APA audit.

APA's services go far beyond quality testing and inspection. Research and promotion programs play important roles in developing and improving panel and engineered wood systems, and in helping users and specifiers better understand and apply products.

For additional information on wood construction systems, contact:

APA – The Engineered Wood Association,
P.O. Box 11700, Tacoma, Washington
98411-0700.

More Information Online

Visit APA's web site at apawood.org for more information on engineered wood products, wood design and construction, and technical issues and answers.

Online publication ordering is also available through the web site.

We have field representatives in many major U.S. cities and in Canada who can help answer questions involving APA trademarked products. For additional assistance in specifying engineered wood products, contact us:

APA – THE ENGINEERED WOOD ASSOCIATION HEADQUARTERS

7011 So. 19th St. ■ P.O. Box 11700
Tacoma, Washington 98411-0700
(253) 565-6600 ■ Fax: (253) 565-7265



www.apawood.org

PRODUCT SUPPORT HELP DESK

(253) 620-7400

E-mail Address: help@apawood.org

The product use recommendations in this publication are based on APA – The Engineered Wood Association's continuing programs of laboratory testing, product research, and comprehensive field experience. However, because the Association has no control over quality of workmanship or the conditions under which engineered wood products are used, it cannot accept responsibility for product performance or designs as actually constructed. Because engineered wood product performance requirements vary geographically, consult your local architect, engineer or design professional to assure compliance with code, construction, and performance requirements.

Form No. A535A
Revised January 2003/0100

